



SERVING HEALTH CARE WORLD WIDE

 @surgicalinstrumentssupplies

 @uniqueempiresurgical

 @unique-empire-b339b51aa

 +92 302 6633155



**SURGICAL**  
**INSTRUMENTS**

[HTTPS://WWW.UNIQUEEMPIRE.COM/](https://www.uniqueempire.com/)

## Percussion Hammers and Aesthesiometers



# Stethoscopes



**01-110**  
PINARD (Aluminum)  
Size: 155 mm



**01-111**  
wooden  
Size: 145 mm



**01-112**  
BOWLES  
Stethoscope  
with diaphragm



**01-113**  
ANESTOPHON



**01-114**  
FORD-BOWLES  
Dual chest piece  
with two outlets



**01-115**  
BOWLES

## Head Mirrors and Head Bands



**01-116**  
ZIEGLER Ø 90mm  
head mirror only  
with rubber coating

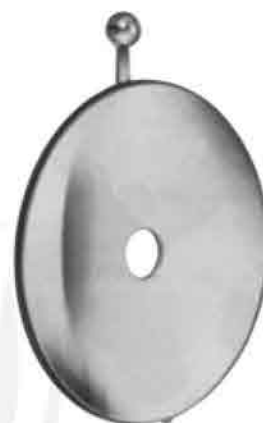

**01-117**  
ZIEGLER Ø 90mm  
head mirror only  
with metal coating



**01-118**  
ZIEGLER  
head band of plastic black

**01-119**  
ZIEGLER  
head band of plastic white



**01-120**  
MURPHY  
head band of celluloid, white



**01-121**  
head band of plastic,  
white, soft pattern



**01-122**  
head mirror with black  
plastic head band.



# Tongue Depressors

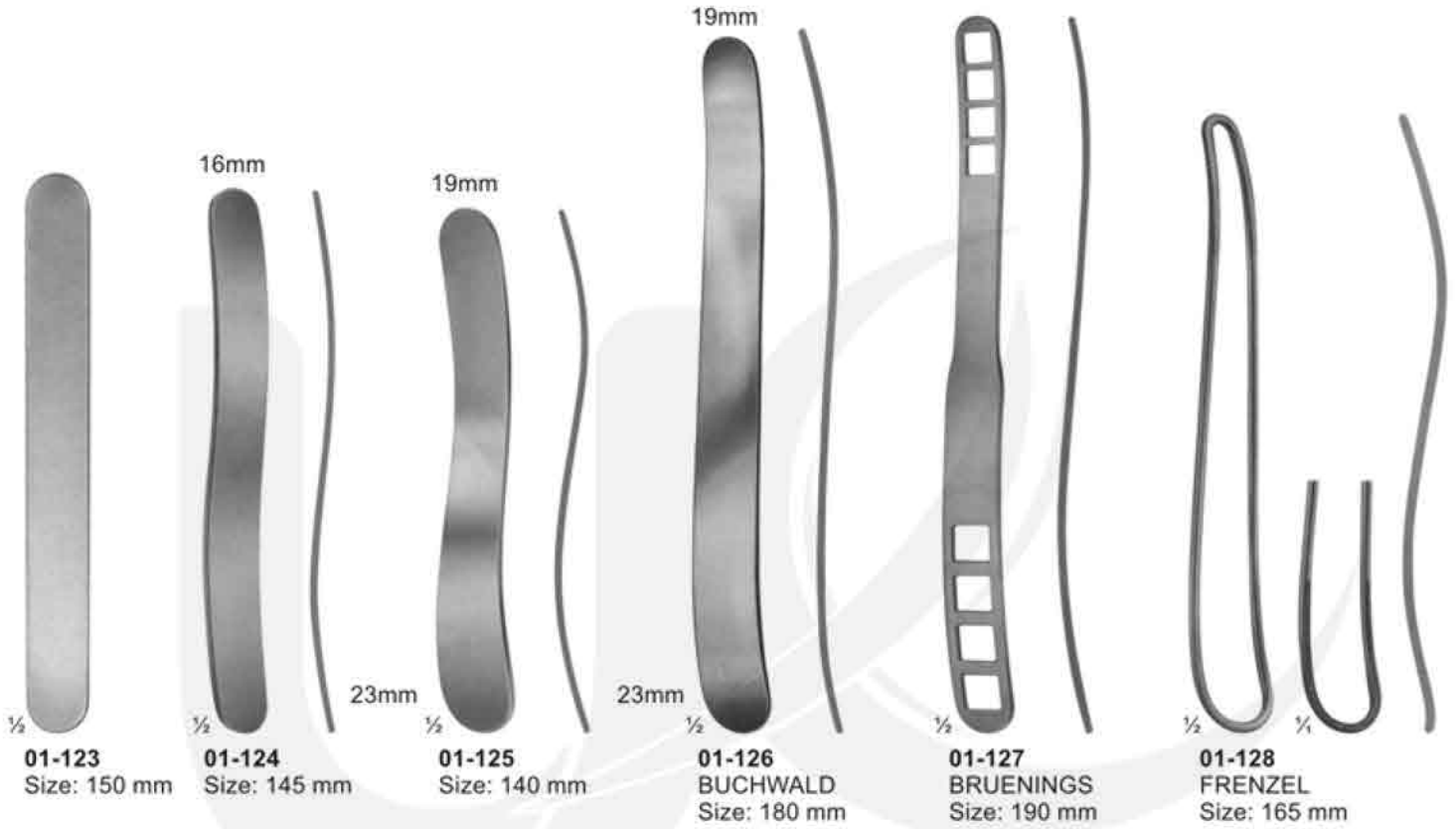

## Instruments for Anaesthesia and Tongue Forceps



1/2  
**01-134**  
SCHIMMELBUSCH  
Ether mask



1/2  
**01-135**  
HEISTER  
Mouth gag  
Size: 130 mm



1/2  
**01-136**  
FERGUSSON-ACKLAND  
Mouth gag  
Size: 145 mm



1/2  
**01-137**  
DENHARDT  
Mouth gag with silicon  
inserts, interchangeable  
Size: 125 mm



1/2  
**01-138**  
ROSER KOENIG  
Mouth gag  
Size: 160 mm, 185 mm

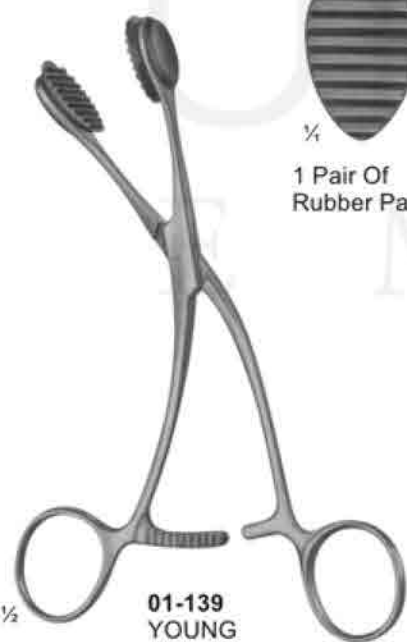

1/2  
**01-139**  
YOUNG  
Size: 165 mm



1/4  
1 Pair Of  
Rubber Pads

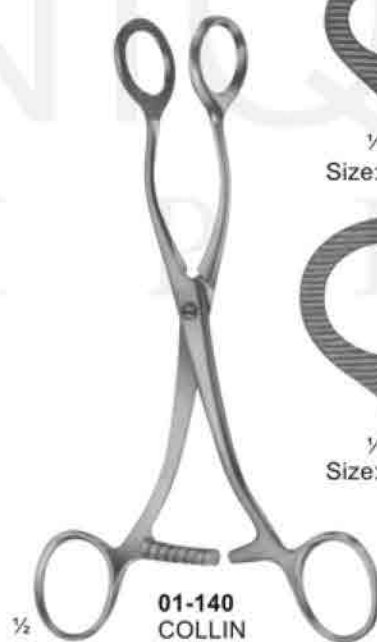

1/2  
**01-140**  
COLLIN  
Size: 160 mm,  
170 mm



1/4  
Size: 160 mm



1/4  
Size: 170 mm

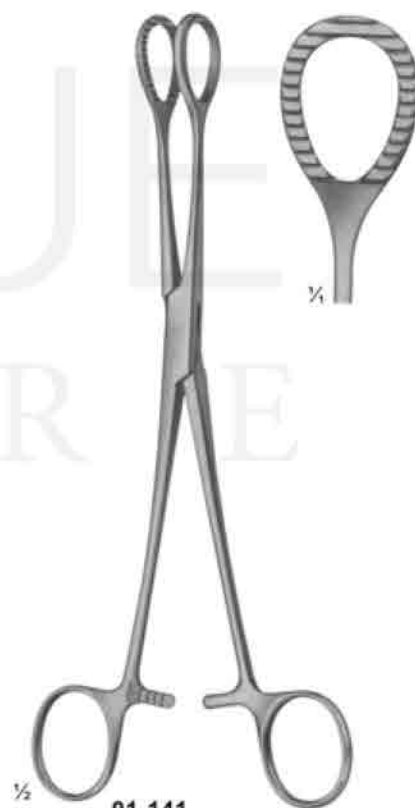

1/2  
**01-141**  
HEYWOOD-SMITH  
modif. Size: 215 mm

## Blood Lancets and Laryngeal Mirrors

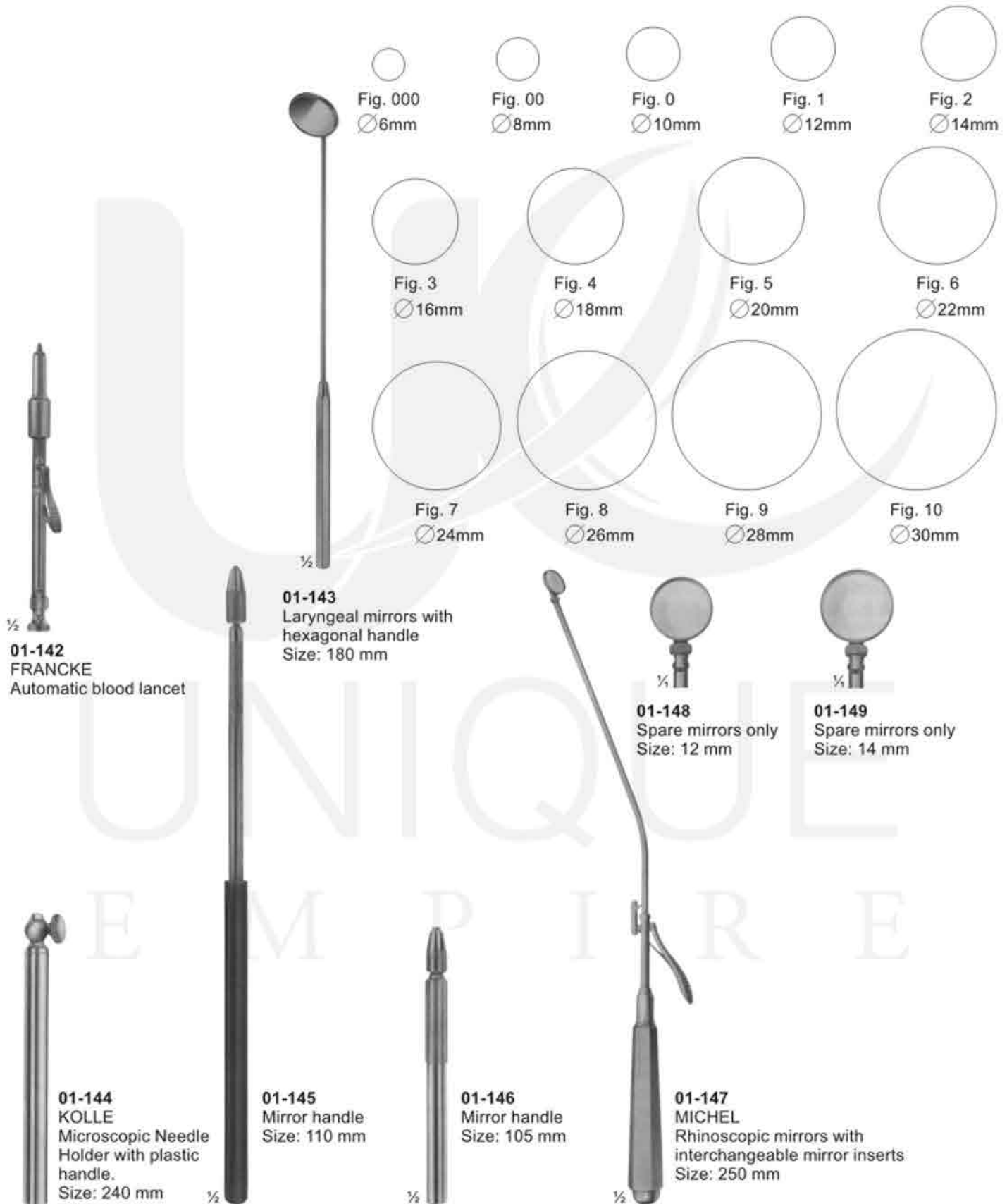

## Laryngoscope and Diagnostic Sets



**01-150**  
Infants  
Size: 150 mm



**01-151**  
Children  
Size: 200 mm



**01-152**  
Adults  
Size: 250 mm



**01-150 - 152**  
MAGILL



**01-154**



**01-153**  
Medium battery handle  
only, 25 mm diam.



**01-153-A**  
Spare bulb  
2.7 volt, for  
otoscopes



**01-153-B**  
Spare bulb  
2.6 volt, for  
ophthalmoscopes



**01-155**



**01-156**  
Otoscope set, consists of  
battery handle without batteries,  
3 ear specula, 1 bulb in valvet lined case



**01-157**  
Diagnostic set, otoscope with three specula,  
nasal speculam, lamp holder, two laryngeal  
mirrors, tongue blade holder



# Laryngoscopes



**01-158  
MILLER**  
Laryngoscope set, consists of battery handle ( without battery )  
with four miller laryngoscope blades

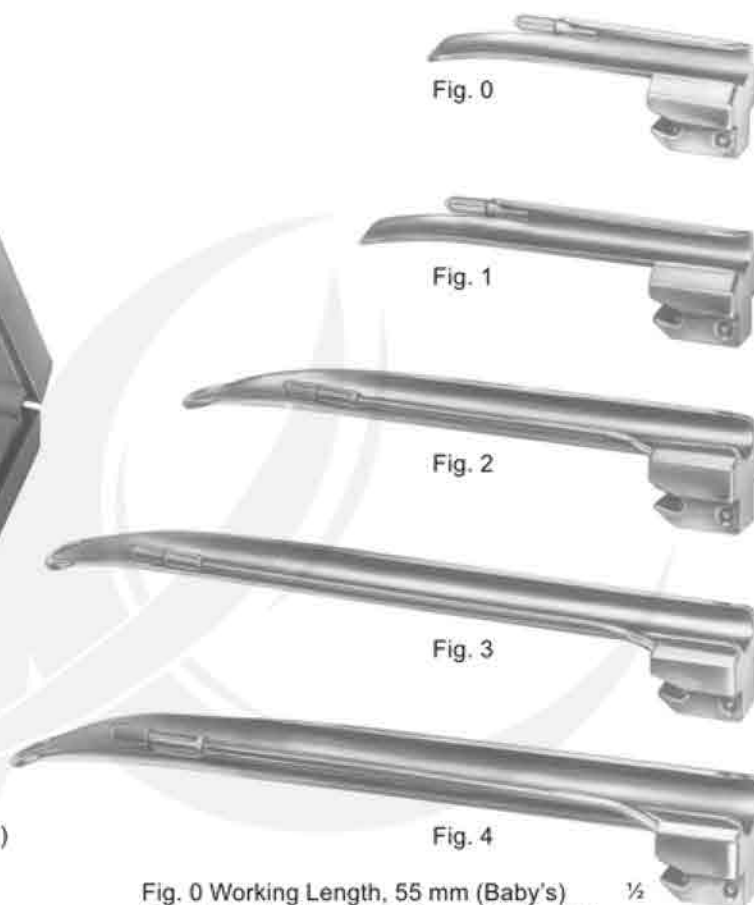

Fig. 0 Working Length, 55 mm (Baby's)  
Fig. 1 Working Length, 80 mm (Children's)  
Fig. 2 Working Length, 130 mm (Adolescent's)  
Fig. 3 Working Length, 170 mm (Women's)  
Fig. 4 Working Length, 180 mm (Men's)



**01-159  
GUEDEL-NEGUS**  
Laryngoscope set, consists of battery handle ( without battery )  
with four miller laryngoscope blades



Fig. 1 Working Length, 70 mm (Children's)  
Fig. 2 Working Length, 90 mm (Adolescent's)  
Fig. 3 Working Length, 110 mm (Women's)  
Fig. 4 Working Length, 135 mm (Men's)

# Laryngoscopes



**01-160**  
McINTOSH  
Laryngoscope Set, Consists Of Battery Handle ( Without Battery )  
With Three McIntosh Blades, Fig. 1, Fig. 2, Fig. 3

**01-161**  
McINTOSH  
Laryngoscope Set, Consists Of Battery Handle ( Without Battery )  
With Five McIntosh Blades, Fig. 0, Fig. 1, Fig. 2, Fig. 3, Fig. 4



Fig. 0



Fig. 1



Fig. 2



Fig. 3



Fig. 4

01-161 A Fig. 0 Working Length, 55 mm (Baby's)  
01-161 B Fig. 1 Working Length, 75 mm (Children's)  
01-161 C Fig. 2 Working Length, 90 mm (Adolescent's)  
01-161 D Fig. 3 Working Length, 110 mm (Women's)  
01-161 E Fig. 4 Working Length, 135 mm (Men's)



**01-162**  
FOREGGER  
Laryngoscope Set, Consists Of Battery Handle ( Without Battery )  
With Three Foregger Blades,  
Fig. 1, Fig. 2, Fig. 3.

**01-163**  
FOREGGER  
Laryngoscope Set, Consists Of Battery Handle ( Without Battery )  
With Four Foregger Blades,  
Fig. 1, Fig. 2, Fig. 3, Fig. 4,



Fig. 1



Fig. 2



Fig. 3



Fig. 4

01-162 A Fig. 1 Working Length, 70 mm (Children's)  
01-162 B Fig. 2 Working Length, 90 mm (Adolescent's)  
01-162 C Fig. 3 Working Length, 110 mm (Women's)  
01-162 D Fig. 4 Working Length, 135 mm (Men's)



**01-164**  
Fiber Optic  
Battery Handle  
30mm diam.



**01-165**  
Fiber Optic  
Battery Handle  
18mm diam.



**01-166**  
Replacement Lamp  
( Krypton ) 2.5 V



**01-167**  
Replacement Lamp  
( Halogen ) 2.5 V

## Examination & Measuring Instruments



**01-168**  
Caliper Of Aluminium  
Graduated in mm & inches  
up to 180mm  
Measuring Range up to 139mm



**01-169**  
VERNIER  
Universal Caliper Of Steel  
Graduated in mm & inches  
up to 180mm  
Measuring Range up to 120mm  
with Vernier in 1/10mm & 1/16"



**01-170**  
CARROLL  
Size: 145 mm  
Finger Goniometer



**01-171**  
TOWNLEY  
Graduated in  
mm & inches  
Size: 115 mm



**01-172**  
COLLIN  
Druck Pressure 72 kg  
Size: 125 mm



**01-173**  
BERTILLON  
Caliper For Measuring The Head  
Size: 320 mm



**01-174**  
CASTROVIEJO  
Caliper  
Size: 75mm



**01-175**  
MOLTGEN  
Goniometer



**01-176**  
Size: 150 mm



**01-177**  
Size: 500 mm





UNIQUE  
E M P I R E

SERVING HEALTH CARE WORLD WIDE



Mohalla Peeple Wala Kotli Behram,  
Sialkot - 51310 Pakistan.



+92-052-4262361



+92 302 6633155



info@uniqueempir.com



<https://www.uniqueempir.com/>



FDA CE